

Data Sheet



Article number: 12620000140710

Description: Threaded pin 620 000 140.710
For M14

Measures

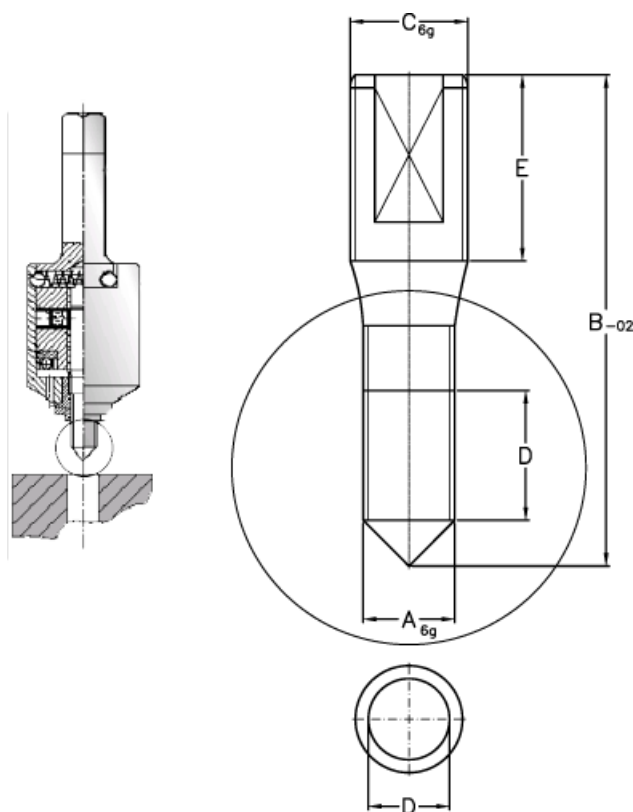

A = M14

B = 83.5

C = M18

D = 28.0

E = 32